

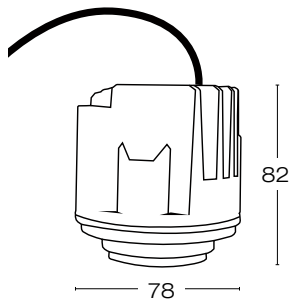

IP54

417 gr.

11. Gris oscuro



Unidades: mm

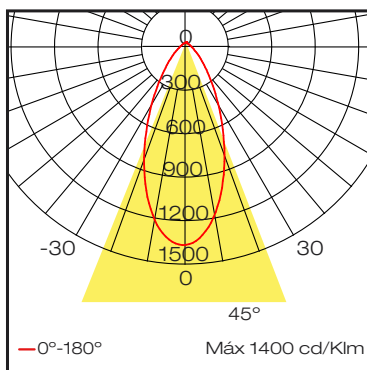

Fuente de luz LED COB fija con cuerpo de aluminio diseñado para una disipación correcta para la larga vida del LED

- Requiere un driver electrónico remoto (no incluido) a 500mA.
- Requiere accesorios para su instalación, ver anexo.

PARÁMETROS ELÉCTRICOS





Potencia (W)	18
Corriente Constante (mA)	500

PARÁMETROS FOTOMÉTRICOS

Temperatura de color (K)	2700
Índice de reproducción cromática	>90
Apertura	45°
Flujo luminoso (lm)	1200
Eficacia (lm/W)	67
Fuente lumínica	LED

Accesorios

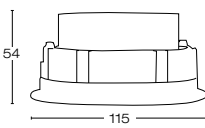
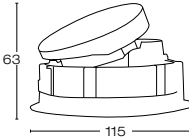
Marcos y anillos (requeridos)

Código	A2021-□□	A2022-□□
Descripción	Fija	Dirigible
Imagen		
Dimensiones (mm)		
Colores	 16. Blanco	 18. Negro
Peso (gr)	147	158
Corte	∅ 105	

Reflector secundario (requeridos)

Código	A2023-□□	A2024-□□
Descripción	Reflector fijo	Reflector dirigible
Imagen		
Dimensiones (mm)		
Colores	 16. Blanco	 18. Negro
		 23. Cromo
Peso (gr)	27	23

Notas: En los espacios en blanco "□□" al final del código, seleccionar el color.
Los reflectores Blanco y Negro tienen un elegante acabado mate.

Accesorios ópticos (opcional)

Código	A200A-18	A200C-15	A200D-15	A200F-15
Descripción	Honeycomb	Cristal transparente para filtro de color	Refractor elíptico	Refractor "soft"
Imagen				